

TRIPO®

乐清市创意影视器材有限公司

地址：浙江省乐清市石帆街道绅坊工业区A座

Yueqing Originality Photography Equipment Co., Ltd.

Address: Buiding A, Shenfang Industrial Zone, Shifan Street,
Yueqing City, Zhejiang Province

Service line: 400-670-6700

www.tripo.cn

MARS

M200RGB MANUAL

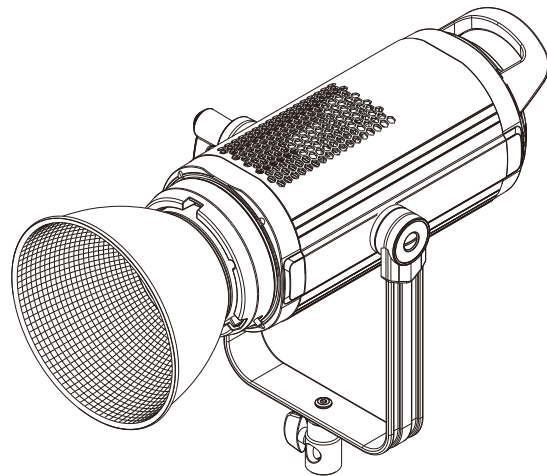

前言

感谢您购买捷宝产品！

本摄影灯光源稳定，显色性好，功能强大，非常适用于影棚拍摄、采访布光、直播、静物拍摄以及视频拍摄等。此灯可以冷暖光无极调节、支持RGB360种颜色可调、支持场景灯光模式。

- 亮度高，光源稳定
- 显色指数高达95以上，真实还原物体色彩
- 大液晶屏高清显示，参数自动保存
- 无线组别0-9、A-F，频道16分组控制，无线调节各组亮度
- 专门设计灯珠保护罩，避免灯珠因触摸、碰撞引起损坏

警告

- ⚠ 请勿私自拆卸产品，如产品出现故障须由本公司或授权的维修人员进行检查维修。
- ⚠ 请保持干燥：请勿用湿手接触产品，亦不可将产品侵入水中或暴露于雨中，请勿将摄影灯放置在高温、高湿的地方。
- ⚠ 请勿让儿童接触本产品。
- ⚠ 闪光灯采用电源插头做为断接装置，应保持随时便于操作。
- ⚠ 在不使用时，请断开电源。
- ⚠ 此机有温度保护功能，当温度过高时进入保护状态，当温度降低后恢复正常。

目录

部件名称	01
液晶显示屏	02
电源管理	04
模式选择	05
组别与频道	09
风扇系统	10
主控、从属模式	11
语言切换	12
蓝牙开关	13
产品参数	14

部件名称

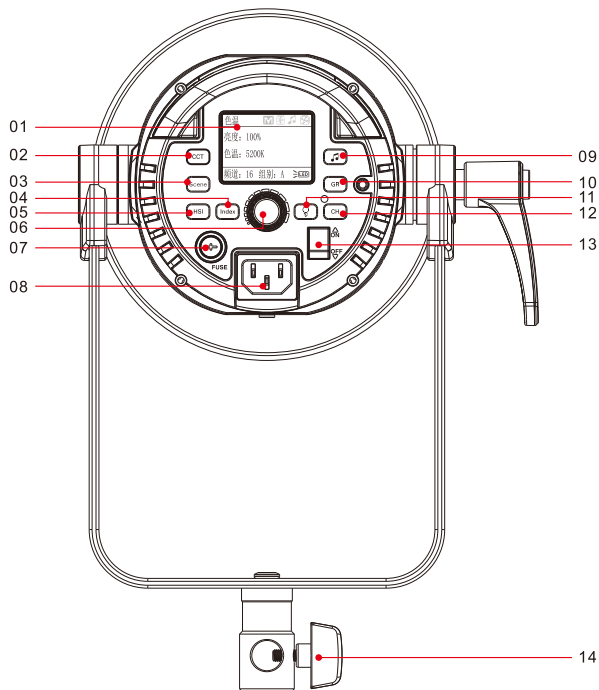

- 01 显示屏 02 CCT色温模式按钮 03 Scene特效场景模式按钮
 04 Index颜色切换按钮 05 HSI色相模式按钮 06 拨盘旋钮
 07 保险丝 08 电源插口 09 按键声音开关 10 GR组别按钮
 11 灯光开关 12 CH频道 13 电源开关 14 托架锁紧旋钮

液晶显示屏

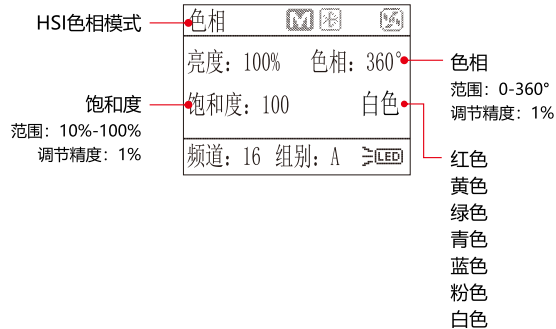
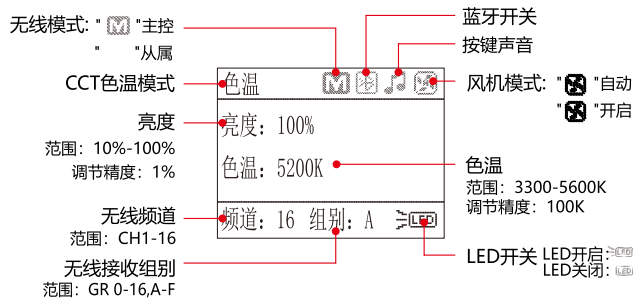

液晶显示屏

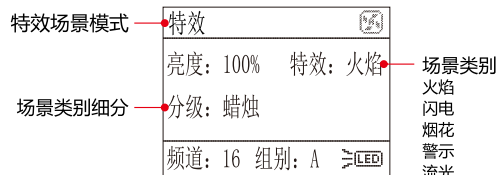

场景类别
火焰
闪电
烟花
警示
流光
派对
闪光灯

火焰: (蜡烛、壁炉、篝火)
闪电: (间断闪、频闪、持续闪)
烟花: (短暂的、持续的、汇演)
警示: (警车、消防车、救护车)
流光: (慢速、中速、快速)
派对: (生日、家庭、俱乐部)
闪光灯: (产品发布会、新闻发布会、狗仔队)

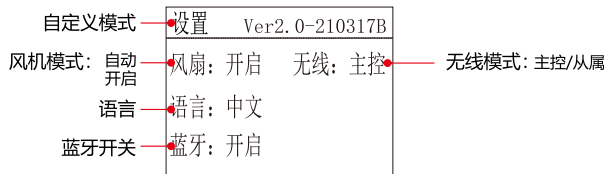

电源管理

·电源开关开到 ON 开启电源

·按 按钮, 开启照明:

关闭照明:

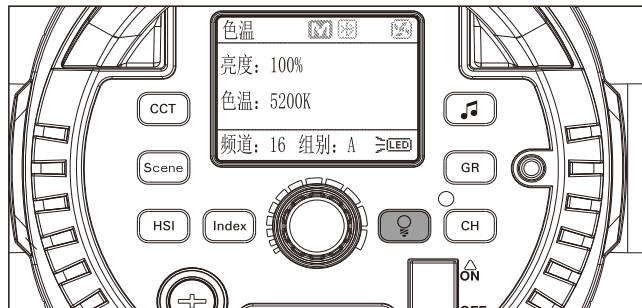

开启照明

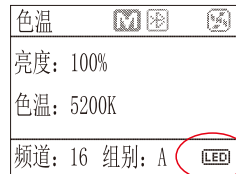

关闭照明

模式选择

CCT色温模式(LED照明模式)

·短按 **CCT** 按钮, 进入色温模式; 短按拨盘旋钮键可以在亮度和色温中切换; 旋转拨盘可以调节参数。

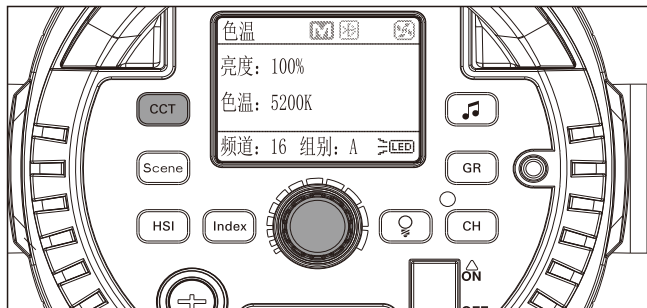

·选项在亮度调节上时, 旋转拨盘旋钮, 可以设置亮度, 调节范围在10%-100%之间调节, 调节精度1%。



·选项在色温调节上时, 旋转拨盘旋钮, 可以设置色温, 调节范围在3300-5600K之间调节, 调节精度100K。

模式选择

Scene特效模式(场景模式)

·短按 **Scene** 按钮, 进入特效模式; 短按拨盘旋钮键可以在亮度、特效和分级中切换, 旋转拨盘键调节参数。

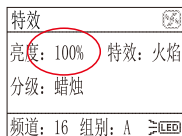
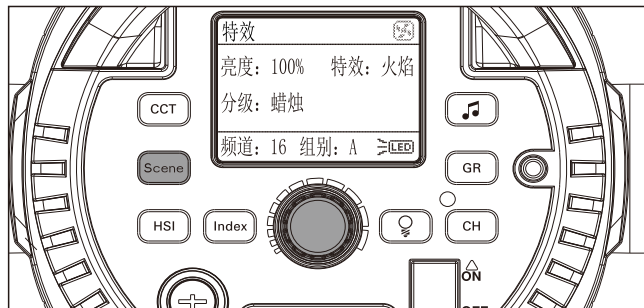

·选项在亮度调节上时, 旋转拨盘旋钮可以设置亮度, 调节范围在10%-100%之间调节, 调节精度1%。

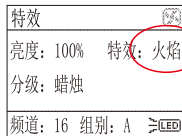

·选项在特效选项上时, 旋转拨盘旋钮可以设置场景类别, 可以在(火焰、闪电、烟花、警示、流光、派对、闪光灯)之间调节。

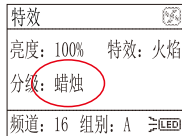

·选项在分级选项上时, 旋转拨盘旋钮可以设置场景。

火焰: (蜡烛、壁炉、篝火)
闪电: (间断闪、频闪、持续闪)
烟花: (短暂的、持续的、汇演)
警示: (警车、消防车、救护车)
流光: (慢速、中速、快速)
派对: (生日、家庭、俱乐部)
闪光灯: (产品发布会、新闻发布会、狗仔队)

模式选择

HSI色相模式 (RGB模式)

·短按 **HSI** 按钮，进入色相模式；短按拨盘旋钮键可以在亮度、色相和饱和度中切换；旋转拨盘可以调节参数。

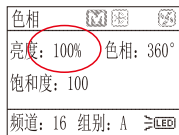
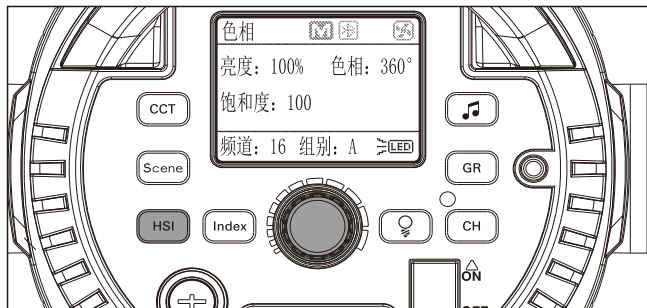

·选项在亮度调节上时，旋转拨盘旋钮，可以设置亮度，调节范围在10%–100%之间调节，调节精度1%。

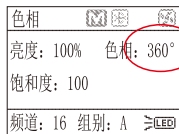

·选项在色相调节上时，旋转拨盘旋钮，可以设置色相，调节范围在0–360° 之间调节，调节精度1°。

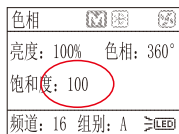

·选项在饱和度调节上时，旋转拨盘旋钮，可以设置色相，调节范围在0–100之间调节，调节精度1°。

模式选择

HSI模式 (RGB模式)

·在HSI模式下；短按 **Index** 按钮，颜色可以红色、黄色、绿色、青色、蓝色、粉色、白色、无颜色选项360色相可调中切换。

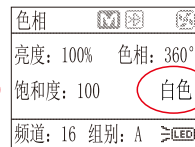
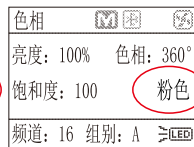
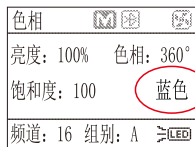
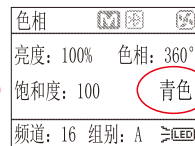
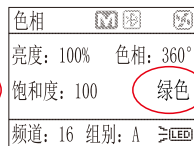
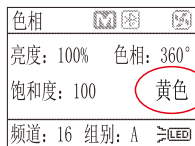

·注：在无颜色选项时，才可以按拨盘键切换亮度、色相、饱和度。

组别与频道

组别设置

- 短按GR按钮，可以设置组别0-9、A-F中切换。
- 屏幕上组别数值被选中组别：A，然后旋转拨盘旋钮设置组别。

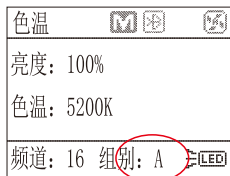
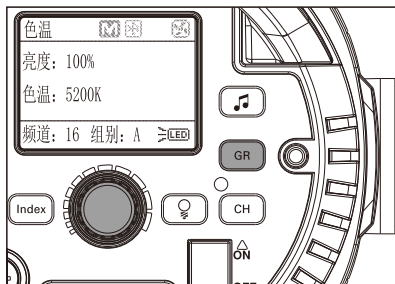

频道设置

- 短按CH按钮，可以设置频道1-16。
- 屏幕上频道数值被选中频道：16，然后旋转拨盘旋钮设置频道。

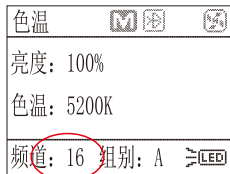
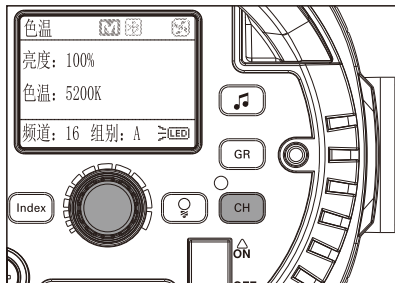

风扇系统

- 长按拨盘旋钮3秒，可以进入自定义界面。
- 短按拨盘，选中【风扇：开启】，再旋转拨盘，可以在自动、开启中切换。

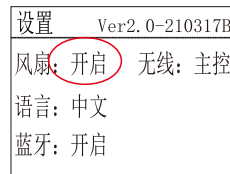
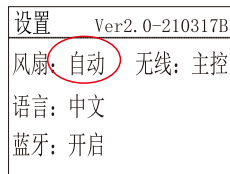

风扇自动模式

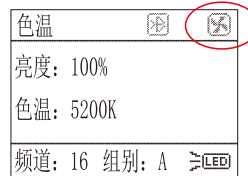

风扇开启模式

- 风扇在自动模式下，灯的温度高起来后会自动开启风扇散热。
- 风扇在启动模式下，风扇会一直开启散热。

主控、从属模式

·长按拨盘旋钮3秒，可以进入自定义界面。

·短按拨盘，选中【无线：主控】，再旋转拨盘，可以在从属、主控切换。

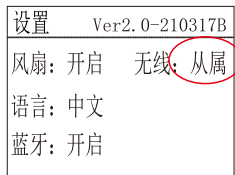
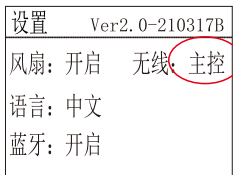

主控模式

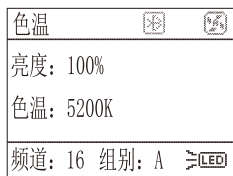

从属模式

·灯在主控模式下，可以直接控制与主灯相同频道，相同组别的其他从属灯。

·灯在从属模式下，可以使用LED遥控器控制灯。

语言切换

·长按拨盘旋钮3秒，可以进入自定义界面。

·短按拨盘，选中【语言：中文】，再旋转拨盘，可以在语言中文、Language:English中切换。

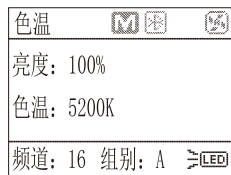
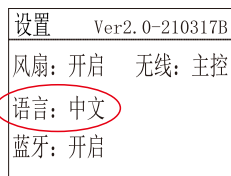

中文模式

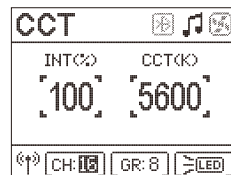

英文模式

蓝牙开关

·长按拨盘旋钮3秒，可以进入自定义界面。

·短按拨盘，选中【蓝牙：开启】，再旋转拨盘，可以在开启、关闭中切换。

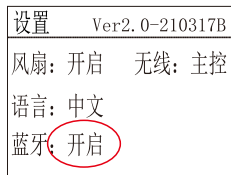

蓝牙开启

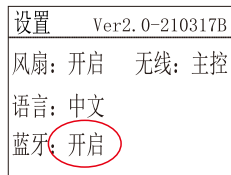

蓝牙关闭

·开启蓝牙后，可以连接手机蓝牙APP

产品参数

型号	M200RGB
功率	白光：200W 暖光：200W RGB：150W 最大输出功率200W
色温	3300K-5600K ±200K
亮度调光	10%-100%
光通量	20000Lm (带标准罩) 1米
发光颜色	RGB+白光+暖光
CRI	CRI≥95
TLCI	TLCI≥96
彩光	全RGB+白光色调节 色相饱和度控制 (3.6万种组合)
电源输入范围	AC 100V~240V
调光	APP、手动调光和遥控调光
情景模式	支持 (21) 种

Preface

Thank you for purchasing triopo products!

This photography light has stable light source, good color rendering and powerful functions. It is very suitable for studio shooting, interview lighting, live broadcast, still life shooting and video shooting.

This light can be adjusted steplessly for cold and warm light, supports RGB360 colors, and supports scene lighting mode.

- High brightness, stable light source
- The color rendering index is as high as 95 or more, and the color of the object is truly restored
- Large LCD screen with high-definition display, parameters are automatically saved
- Wireless group 0-9, A-F, channel 16 group control, wirelessly adjust the brightness of each group
- Specially designed lamp bead protection cover to avoid lamp bead damage caused by touch and collision

Warn







-  Do not disassemble the product without permission. If the product fails, it must be checked and repaired by the company or authorized maintenance personnel.
-  Keep it dry: Do not touch the product with wet hands, do not immerse the product in water or expose it to rain, and do not place the camera in a place with high temperature and high humidity.
-  Do not let children touch this product.
-  The flash adopts the power plug as the disconnecting device, which should be kept easy to operate at any time.
-  Please disconnect the power when not in use.
-  This machine has a temperature protection function, when the temperature is too high, it will enter the protection state, and it will return to normal when the temperature is lowered.

Table of Contents

Part Name	01
LCD	02
Power management	04
Mode selection	05
Groups and Channels	10
Fan system	11
Master, slave mode	12
Language switch	13
Bluetooth switch	14
Product parameters	15

Part name

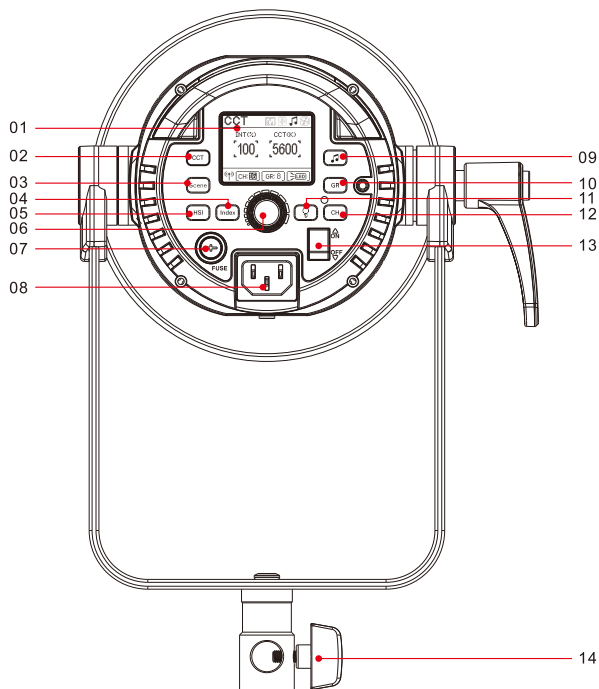

- 01 Display 02 CCT color temperature mode button
 03 Scene effect scene mode button 04 Index Color Toggle Button
 05 HSI Hue Mode Button 06 Dial Knob 07 Fuse 08 Power Inlet
 09 Button Sound Switch 10 GR Group Button 11 Light Switch
 12 CH Channel 13 Power Switch 14 Bracket Lock Knob

LED

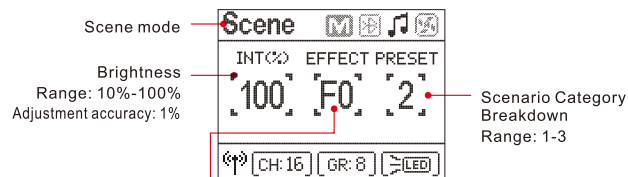
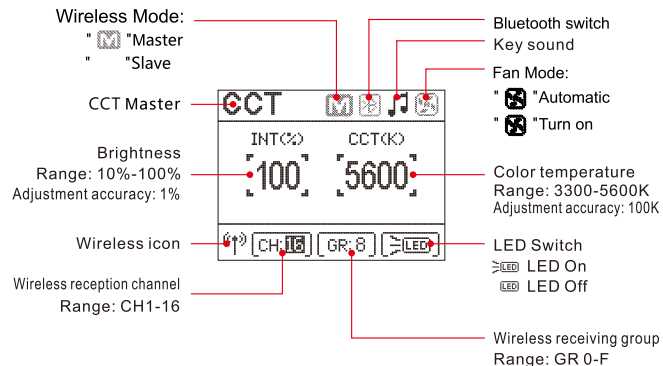

- Scene category**
- F0: flame effects (candles, fireplaces, bonfires)
 - F1: Lightning effect (intermittent flashing, strobe flashing, continuous flashing)
 - F2: Fireworks effect (ephemeral, continuous, extravagant)
 - F3: Warning effect (police, fire truck, ambulance)
 - F4: Streamer effect (slow, medium, fast)
 - F5: Party effect (birthday, family, club)
 - F6: Flash effect (product launch, press conference, paparazzi)

LED

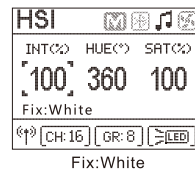
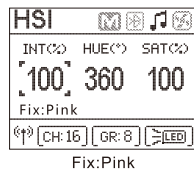
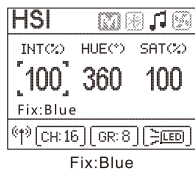
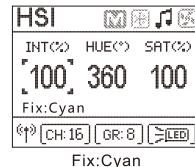
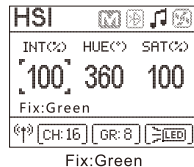
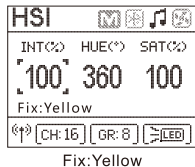
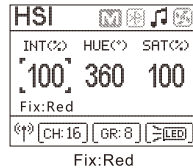
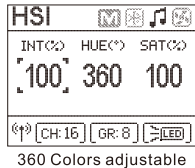
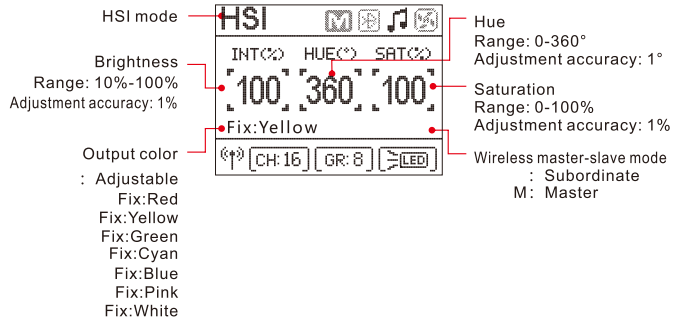

Power management

- Turn the power switch ON to turn on the power
- Press the button to turn on the lighting:
- Turn off lighting:

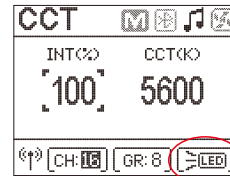
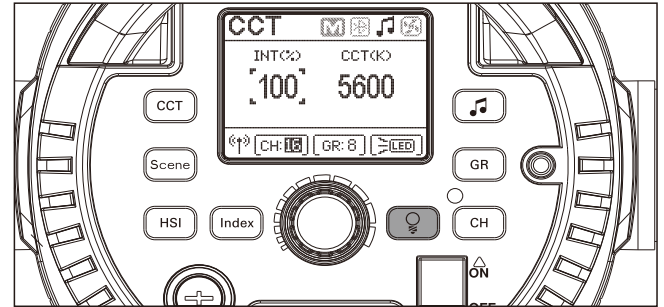

Turn on the lighting

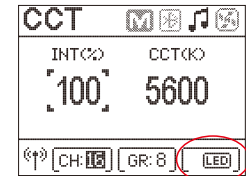

Turn off lighting

Mode selection

CCT Color temperature mode

Short press the **CCT** button to enter CCT mode; short press the dial knob to switch between brightness adjustment '100' and color temperature adjustment '5600'.

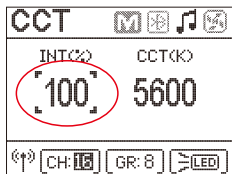
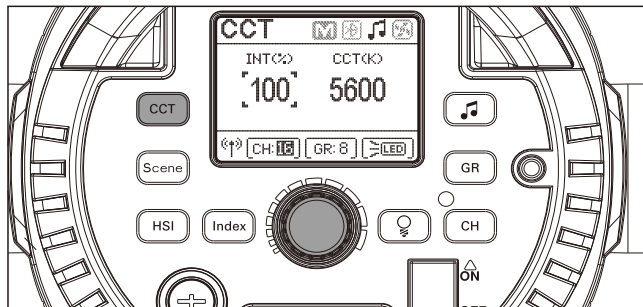

·When the option is on '100' brightness adjustment, turn the dial knob to set the brightness, the adjustment range is between 10%-100%, and the adjustment accuracy is 1%.

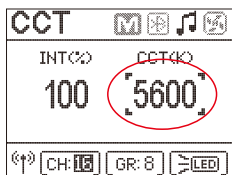

·When the option is on the '5600' color temperature adjustment, rotate the dial knob to set the color temperature, the adjustment range is between 3300-5600K, and the adjustment accuracy is 100K.

Mode selection

Scene effect mode

·Short press the **Scene** button to enter the Scene mode; short press the dial knob to switch between brightness adjustment '100', scene category 'F0', and scene category subdivision '2'.

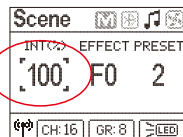
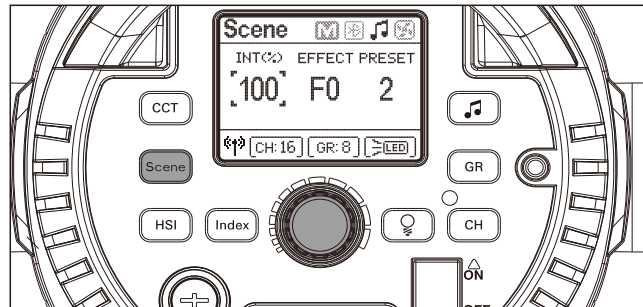

· When the option is on '100' brightness adjustment, turn the dial knob to set the brightness, the adjustment range is between 10%-100%, and the adjustment accuracy is 1%.

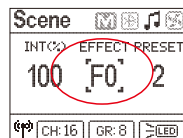

· When the option is on the 'F0' scene category option, turn the dial knob to set the scene category, and the adjustment range is between 0-6.

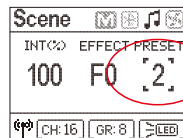

· When the option is on the '2' scene category subdivision option, turn the dial knob to set the scene, and the adjustment range is between 1-3.

Mode selection

Scene effect mode

Scene category:

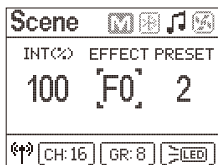

F0: Fire effect

F0-1 (Candle)
F0-2 (fireplace)
F0-3 (Bonfire)

F1: Lightning effect

F1-1 (intermittent flashing)
F1-2 (strobe)
F1-3 (continuous flashing)

F2: Fireworks effect

F2-1 (brief)
F2-2 (continuous)
F2-3 (Exhibition)

F3: Warning effect

F3-1 (police car)
F3-2 (fire truck)
F3-3 (Ambulance)

F4: Streamer effect

F4-1 (slow)
F4-2 (medium speed)
F4-3 (Fast)

F5: Party Effect

F5-1 (birthday)
F5-2 (Family)
F5-3 (Club)

F6: Flash effect

F6-1 (Product Launch)
F6-2 (press conference)
F6-3 (paparazzi)

Mode selection

HSI mode (RGB mode)

Short press the **HSI** button to enter the HSI mode; in no color option mode, short press the dial knob to switch between brightness adjustment '100', hue adjustment '360' and saturation adjustment '100'.

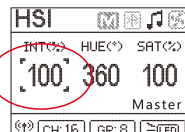
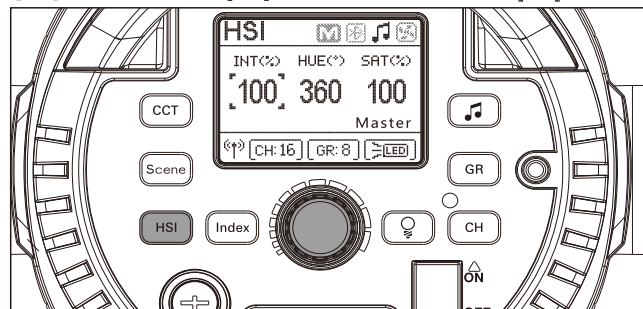

- When the option is on '100', brightness adjustment, turn the dial knob to set the brightness, the adjustment range is between 10%-100%, and the adjustment accuracy is 1%.

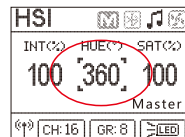

- When the option is '360', Hue adjustment, rotate the dial knob to set the hue, the adjustment range is between 0-360°, and the adjustment precision is 1°.

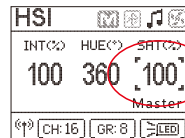

- When the option is on '100', saturation adjustment, turn the dial knob to set the hue, the adjustment range is between 0-100, and the adjustment precision is 1.

Mode selection

HSI mode (RGB mode)

·In HSI mode; short press the **Index** button, the color can be switched between red, yellow, green, cyan, blue, pink, white, no color options 360 hue adjustable.

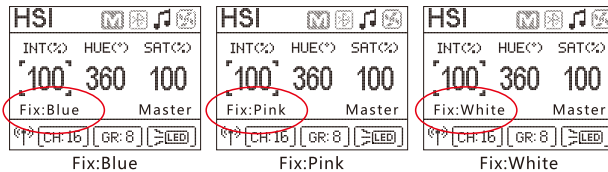
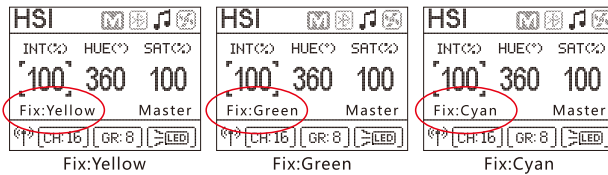

Groups and Channels

Group settings

·Short press the GR button to switch between groups 0-9 and A-F.
·The group value on the screen is selected Group: 8, and then turn the dial knob to set the group.

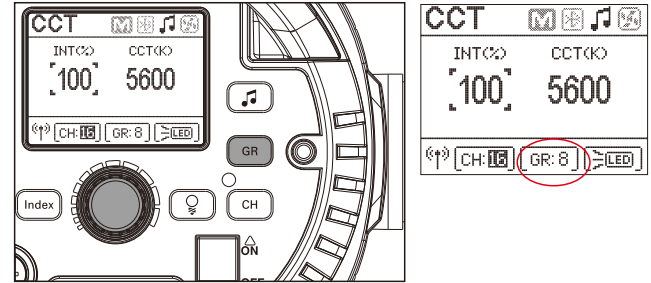

Channel settings

·Short press the CH button to set channels 1-16.
·The channel value on the screen is selected Channel: 16, and then turn the dial knob to set the channel.

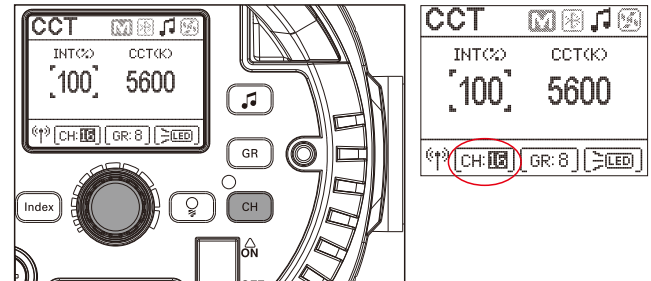

Fan system

- Press and hold the dial knob for 3 seconds to enter the custom interface.
- Short press the dial, select [Fan: On], and then rotate the dial to switch between automatic and on.



Fan Auto Mode



Fan On Mode

- When the fan is in automatic mode, when the temperature of the lamp rises, the fan will be automatically turned on to dissipate heat.
- When the fan is in the startup mode, the fan will always be turned on to dissipate heat.

Master, slave mode

- Press and hold the dial knob for 3 seconds to enter the custom interface.
- Short press the dial, select [Wireless: Master], and then rotate the dial to switch between slave and master.

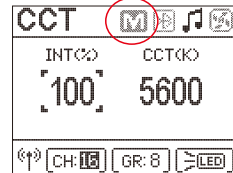

Master mode

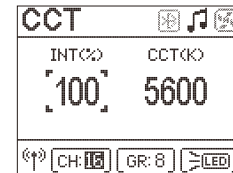

Slave mode

- In the master control mode, the lamp can directly control other slave lamps in the same channel and group as the master lamp.
- The light is in slave mode, you can use the LED remote control to control the light.

Language switch

- Press and hold the dial knob for 3 seconds to enter the custom interface.
- Short press the dial, select [Language: Chinese], and then rotate the dial to switch between languages Chinese and Language: English.

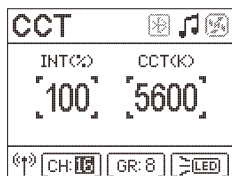
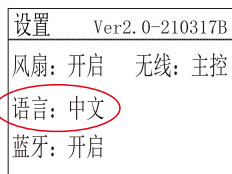
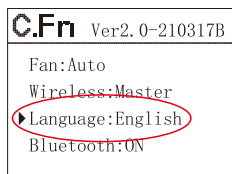
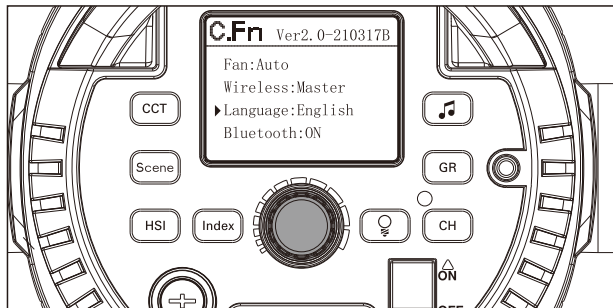

English mode

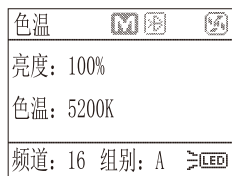

Chinese mode

Bluetooth switch

- Press and hold the dial knob for 3 seconds to enter the custom interface.
- Short press the dial, select [Bluetooth: On], and then rotate the dial to switch between on and off.

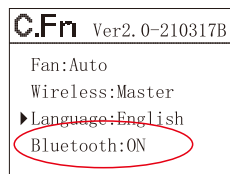

Bluetooth on



Bluetooth off

- After turning on Bluetooth, you can connect to the mobile phone Bluetooth APP.

Product parameters

Model	M200RGB
Power	White light: 200W Warm light: 200W RGB: 150W Maximum output power 200W
Color temperature	3300K-5600K ±200K
Brightness dimming	10%-100%
Luminous flux	20000Lm (with standard cover) 1 meter
Glow color	RGB+white light+warm light
CRI	CRI≥95
TLCI	TLCI≥96
IPL	Full RGB + white light color adjustment Hue saturation control (36,000 combinations)
Power input range	AC 100V~240V
Dimming	APP,Manual dimming and remote dimming
Profile	Support (21) kinds